

EOS 60

Item number: 34020

Material: Vitreous china

Color/Finish: White/ glazed from four sides

Installation: Vessel/ above-counter

Overall Dimensions: 23.4" L x 15.6" W x 4.7" H

Interior Dimensions (basin area): 20.7" L x 12.9" W x 3.9" H

Foot print: 21.1" L x 13.4" W

Drain hole: 1-3/4" Interior Diameter

Approx. weight: 29 lbs

Features: Without overflow and without faucet hole. Glazed from four sides

Recommended accessory (not included): Always-open drain i.e. grid drain, or e.g. Decolav Drain Ref. 9290

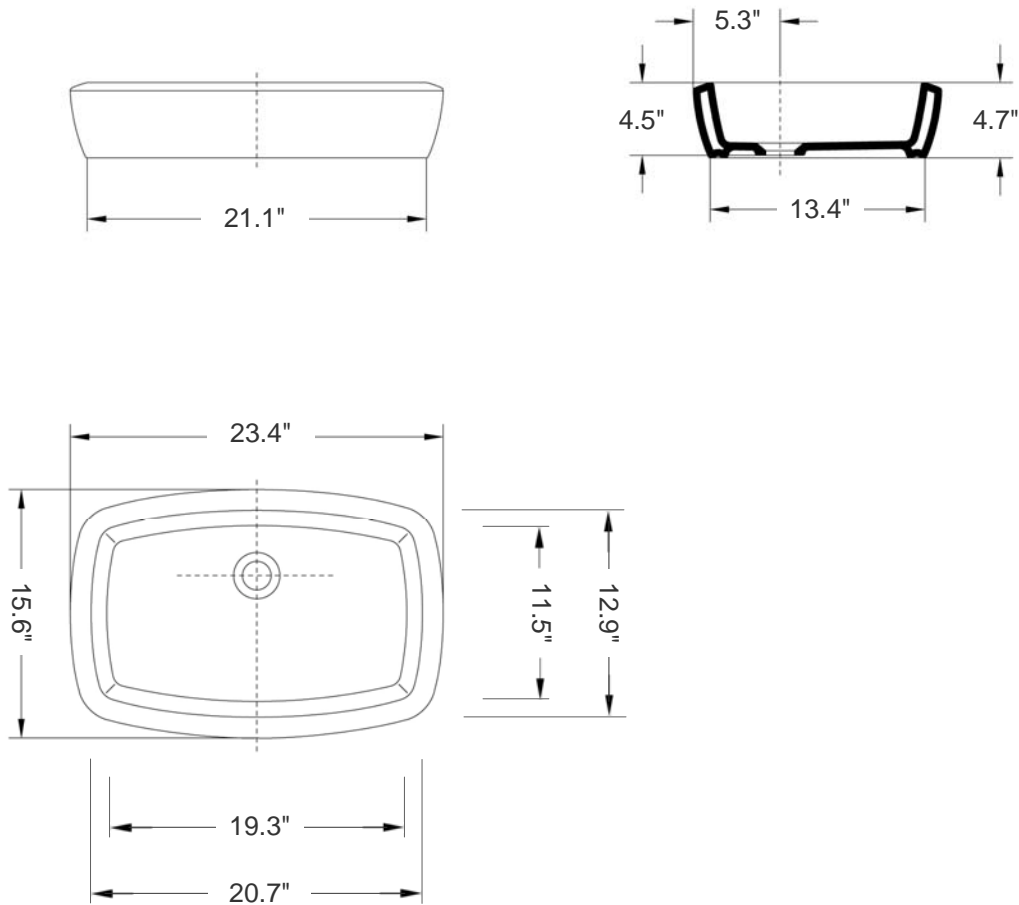

All dimensions are nominal
Drain not included. Shown only for photographic purposes

BISSONNET

Tel. (610) 454-1295 · Fax (610) 454-9385 · info@bissonnet.net · www.bissonnet.net